

SERIES



FORM FOLLOWS SUNSHINE

Striking design meets innovative technology.

The new K-Series from KBL captivates not only with its ravishing appearance, but also with its trendsetting technology.

Born from the pen of Etienne Salomé, a designer known for his work for Bugatti automobiles, the new solarium series

has gained its unique design with many possible variations. A mesmerizing combination of form and light, combined with state-of-the-art technology, creates a whole new feeling of ultimate relaxation during a short holiday.

With its dimensions of 2300 mm width and 1373 mm depth, the K-Series by KBL is also ideal for smaller cabin sizes, and is thus the optimal choice for fitness studios.

K7

To infinity and beyond.

Infinity Mirror

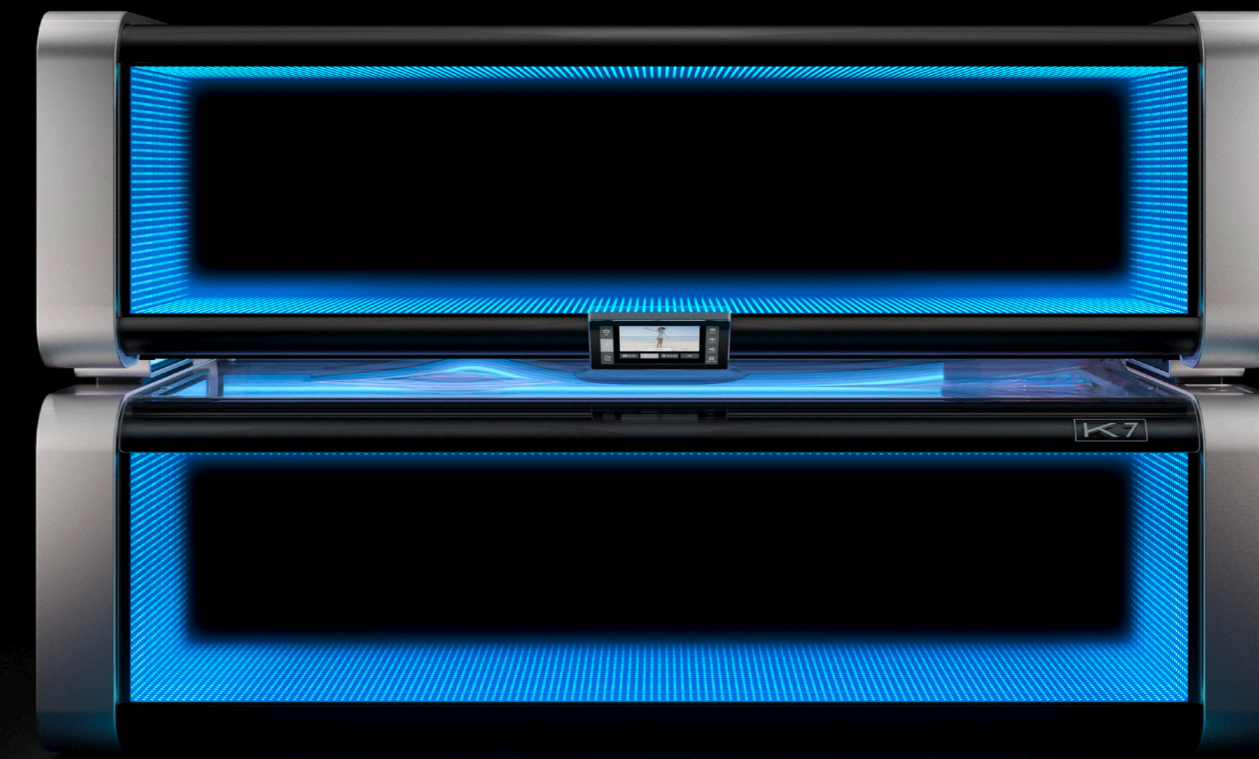

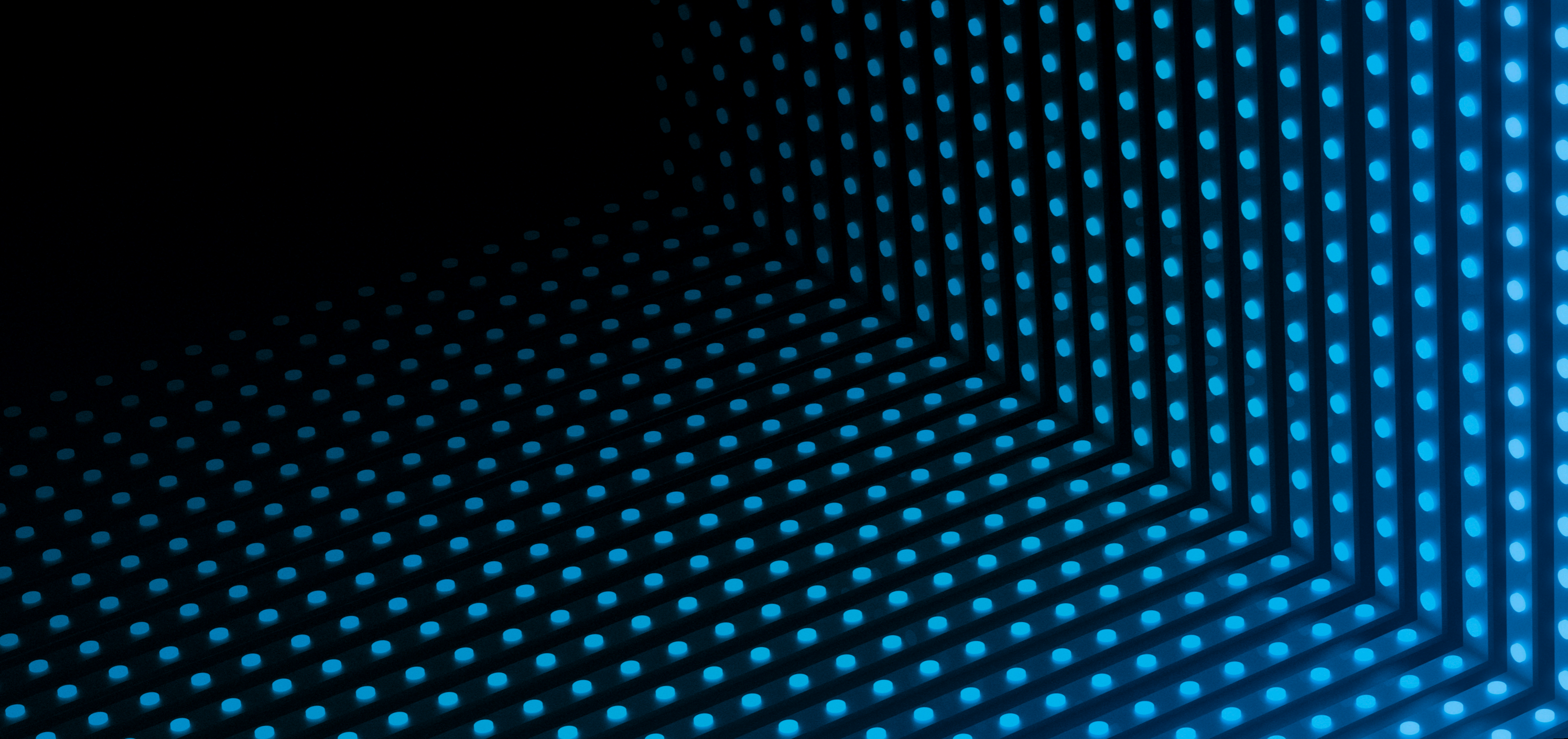

TO INFINITY AND BEYOND

One of the highlights of the K-Series is the Infinity Mirror. Light effects create a sense of depth that seems to extend to infinity. A magical illusion that never fails to fascinate from any angle.

The new SmartControl Display allows the selection of almost unlimited color combinations of the RGBW LEDs, which adapt perfectly to any environment.

| Infinity Mirror & LED Lighting





SHINE WITH DESIGN

The LightArt design version of the K-Series offers numerous individual motifs that make it an absolute eye-catcher. Its design creates a very special vibe and reflects the spirit of the company.

FLEXIBILITY & DURABILITY

The LightArt design is based on two production processes. The polymer banner technology facilitates maximum flexibility and quick design changes. For even more robust use, the design can alternatively be printed on acrylic panels.

| LightArt Panel

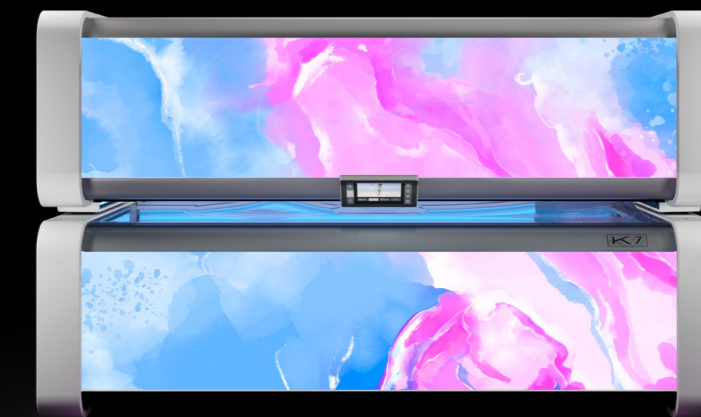
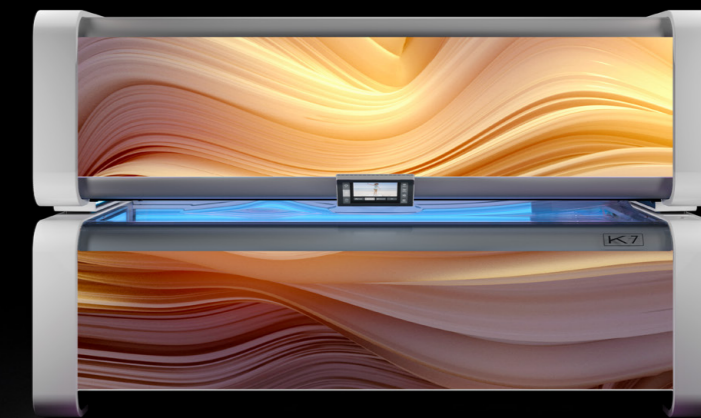

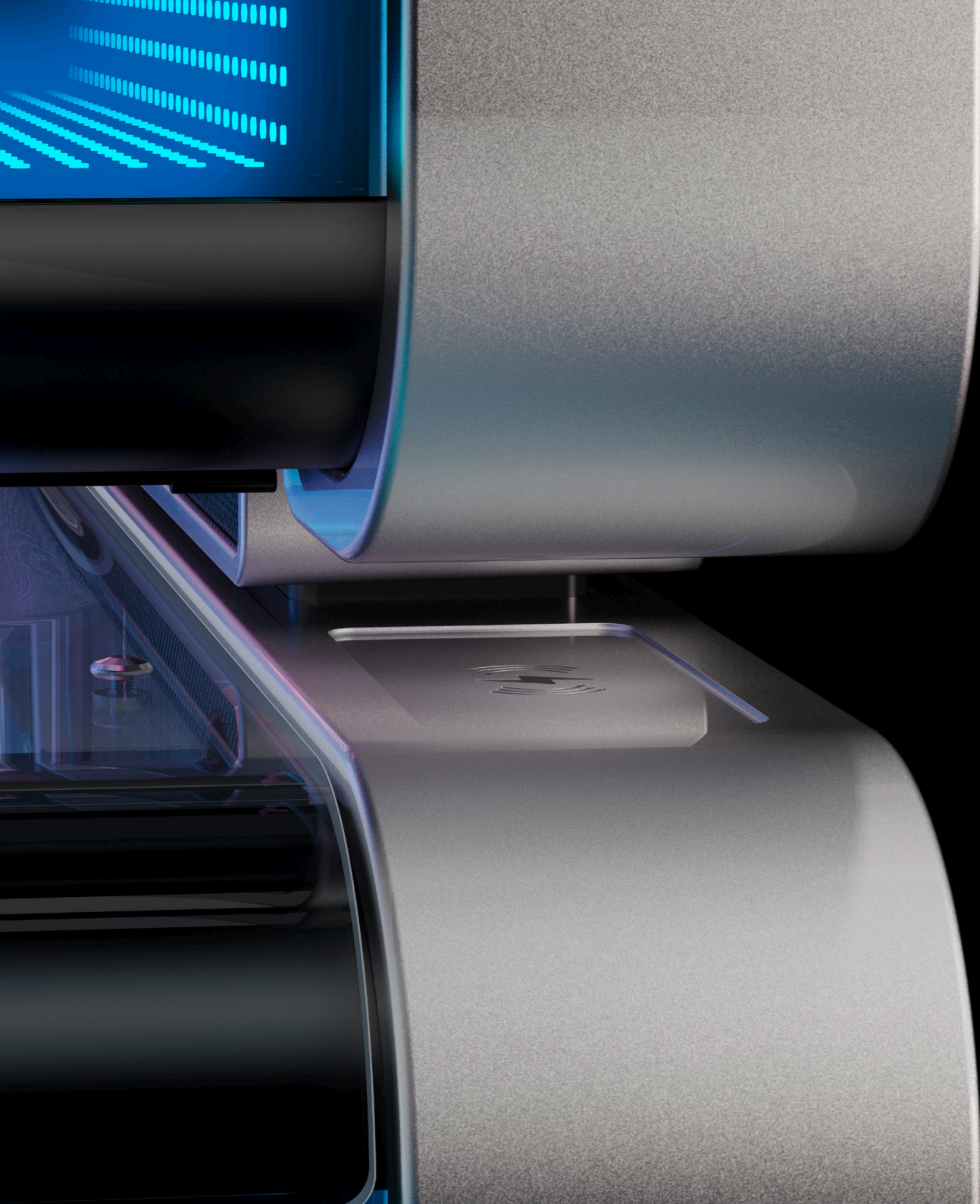

DYNAMIC COLORS

The K-Series is available in 3 different chassis colors. Magic Silver, Copper Rose and Wonder White. All matched to each other. This color concepts satisfies every wish.

STRIKING OPTICS



Magic Silver

TRENDSETTER



Copper Rose

RADIANT APPEARANCE



Wonder White

CHASSIS K6 K6S

42 **04**
LAMPS FACIALS

Lightselect: hybridSun, extraSun, smartSun

Face: pureFacials, SunSphere Facials

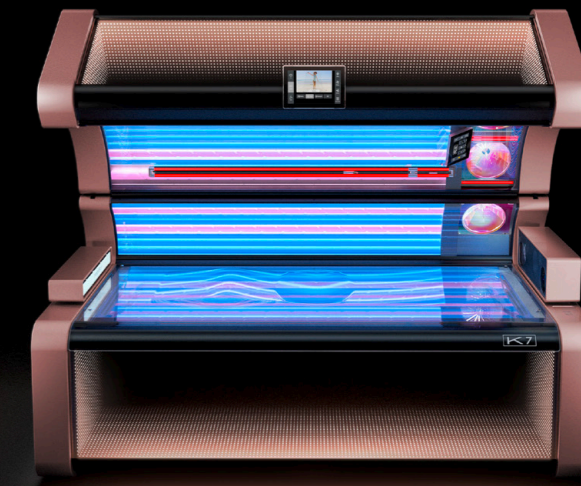

CHASSIS K7 K7S

46 **04**
LAMPS FACIALS

Lightselect: hybridSun, extraSun, smartSun

Face: pureFacials, SunSphere Facials

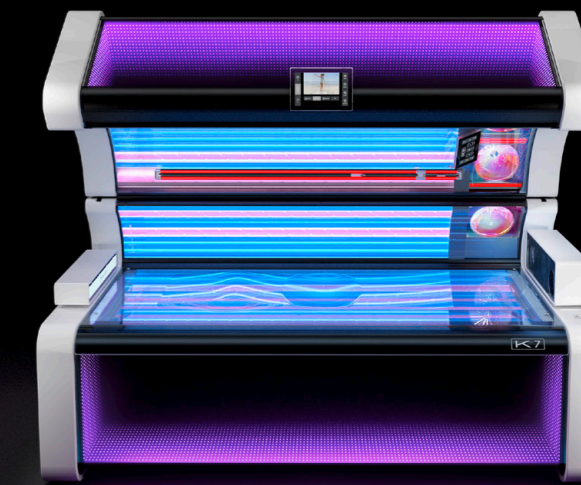

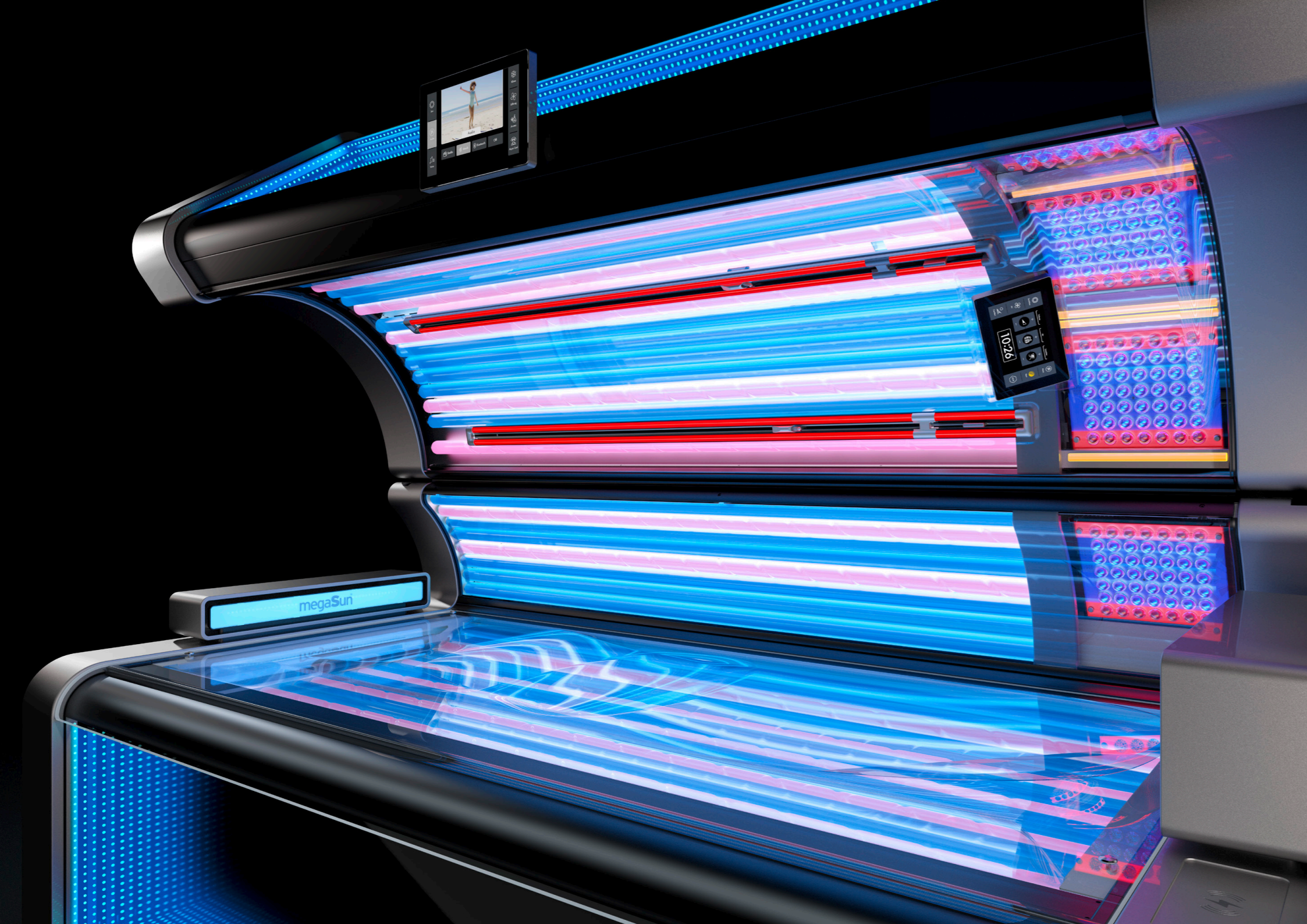

SUNSPHERE

A QUANTUM LEAP IN UV TECHNOLOGY.



SunSphere UVA-LED's



SunSphere Beauty LED's



UVB-ThinLights



SunSphere Facials



SunSphere Shoulders

With the success of the P9S, LED technology has become an integral part of the sunbed sector. This quantum leap in terms of spectral technology is now continued in the K6S and K7S. High-performance LEDs generate

the desired wavelengths for a beautiful and gentle tan. At the same time, aspherical lenses in front of the LEDs guarantee absolutely even illumination of the face and décolleté. **See and feel the results instantly.**

UNCOMPROMISING EFFICIENT

SunSphere technology produces a balanced spectrum for excellent tanning results - with significantly lower energy consumption. The considerably reduced electricity demand and the much longer service life compared to conventional high-pressure bulbs save energy and purchase costs in the long term. This efficient technology now also features in the K-Series.



120 W Facials
20 W Shoulders

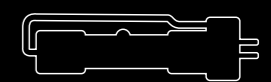

800 W HP-Bulb
250 W HP-Bulb

EXAMPLE: 120 W SUNSPHERE FACIALS ARE EQUAL TO THE TANNING PERFORMANCE OF A 800 W HIGH PRESSURE-BULB.

UV TECHNOLOGY

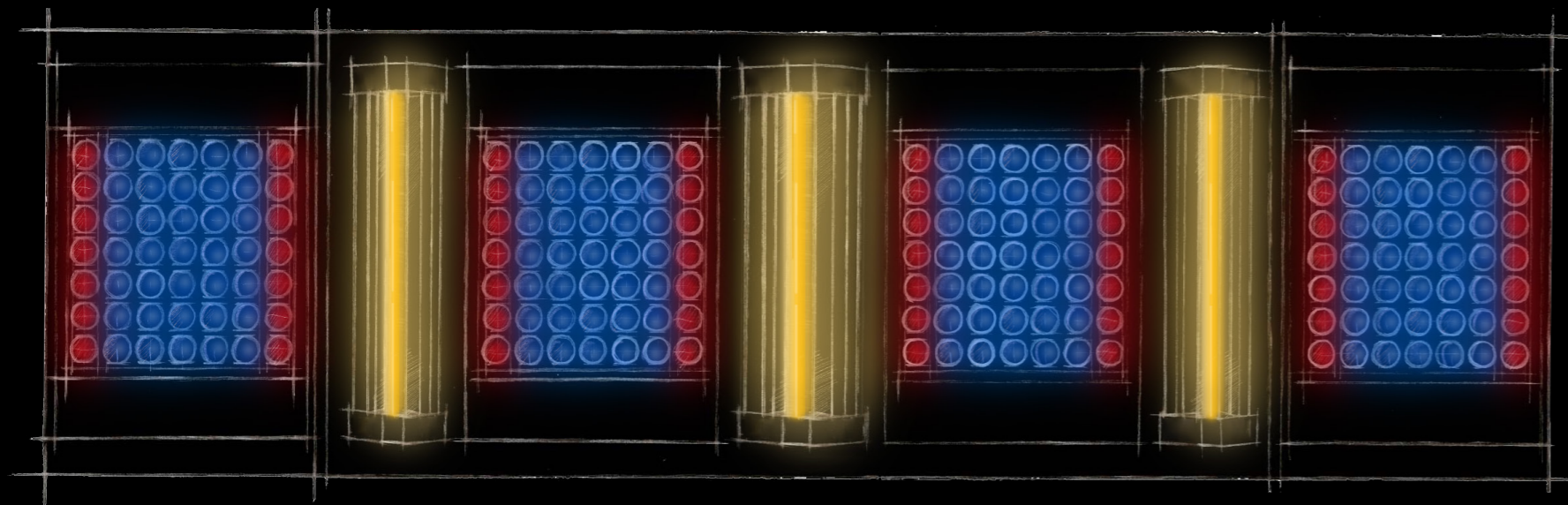

140 UVA LEDs

A beautiful tan - just the way you like it. 140 blue UVA LEDs guarantee optimally dosed direct pigmentation of the face and décolleté.

3 UVB SPECIAL LAMPS

The perfectly balanced dose from three yellow special UVB lamps builds up new colour pigments in the skin and stimulates vitamin D production.

56 BEAUTY LEDs

During the tanning session, the K6S and K7S treat the face and décolleté with 56 red Beauty LEDs and at the same time stimulate the oxygen supply to the skin. For a stunning complexion and a velvety-soft skin feeling.





SUNSHINE ALL AROUND

FOR THE FIRST TIME, LED TECHNOLOGY AS STANDARD IN MEGASUN SHOULDER TANNERS.

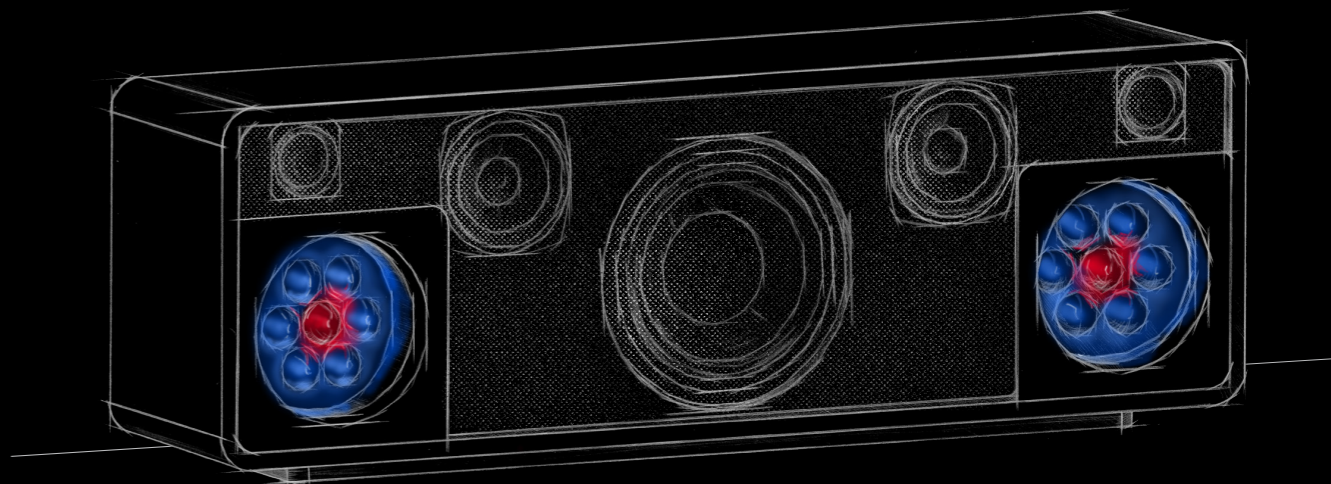

The high-power LEDs and aspherical glass lenses guarantee a flawless complexion and maximum tanning comfort in the shoulder area. This is a completely new technology standard that distinguishes the K-Series.

 12 UVA LEDs

 2 BEAUTY LEDs

NEW VENTILATION CONCEPT



A FRESH FACE

With AirBreeze, the K-Series is breaking new ground in ventilation technology for sunbeds. The individually adjustable ventilation intensity for the body and face offers maximum comfort. In addition, the direction of the air flows in the décolleté and face area can be adjusted individually.

SOOTHING BREEZE

For the first time, the air is pleasantly distributed over the entire tanning tunnel by two complete continuous air outlets. A draught-free foot fan rounds off the system. For an even cooler relaxation.



Airflow in best shape.

AirPro

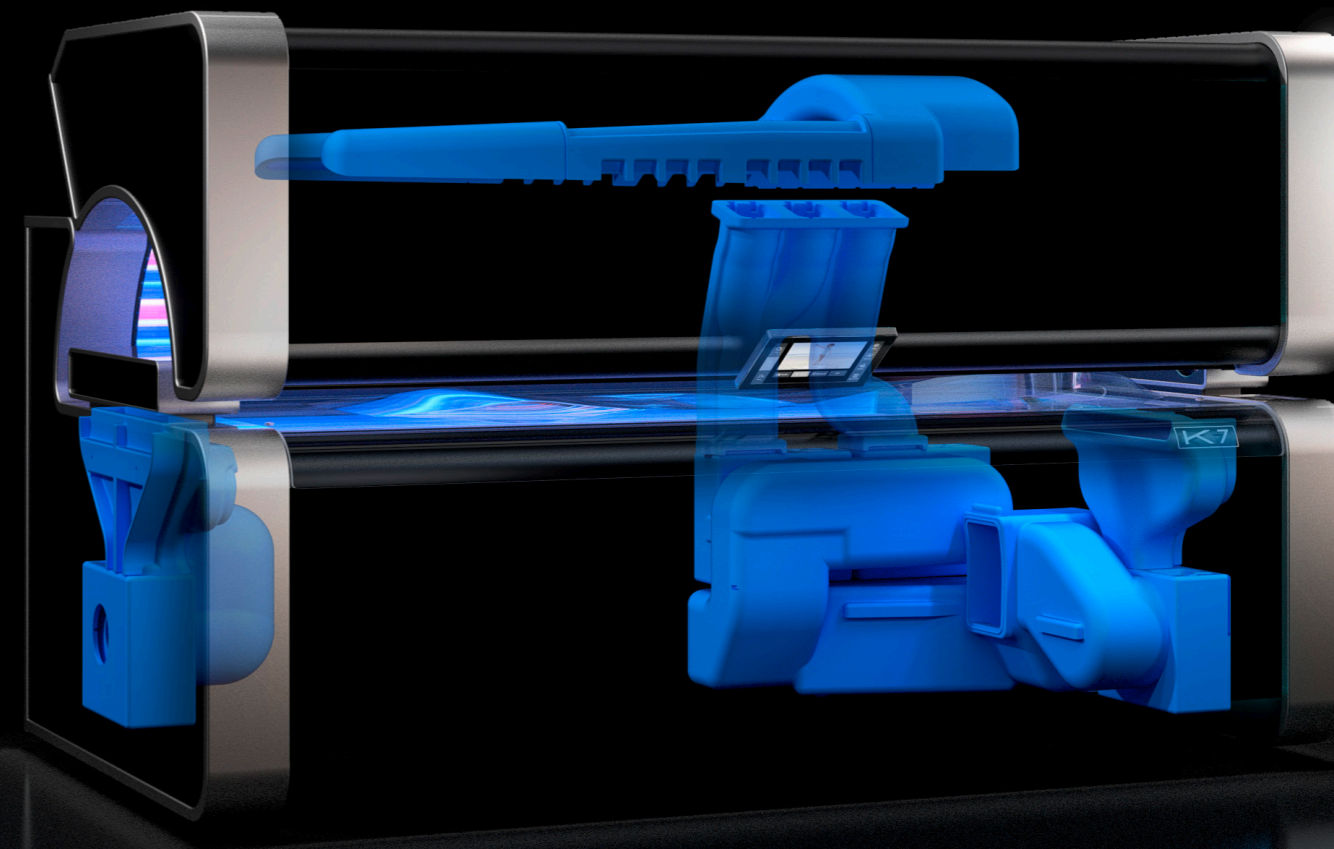



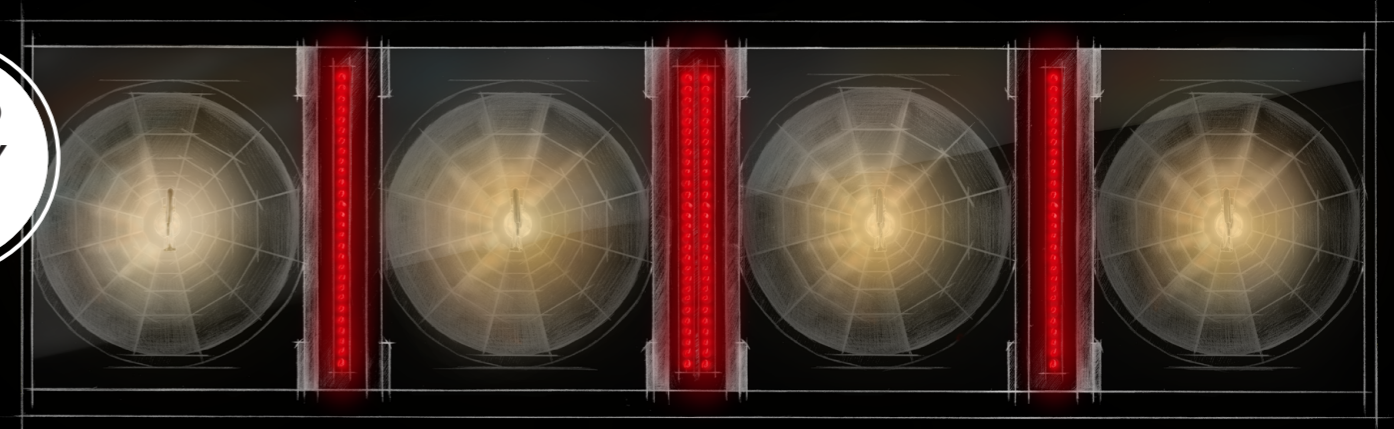

NANO
BEAUTY
LED'S

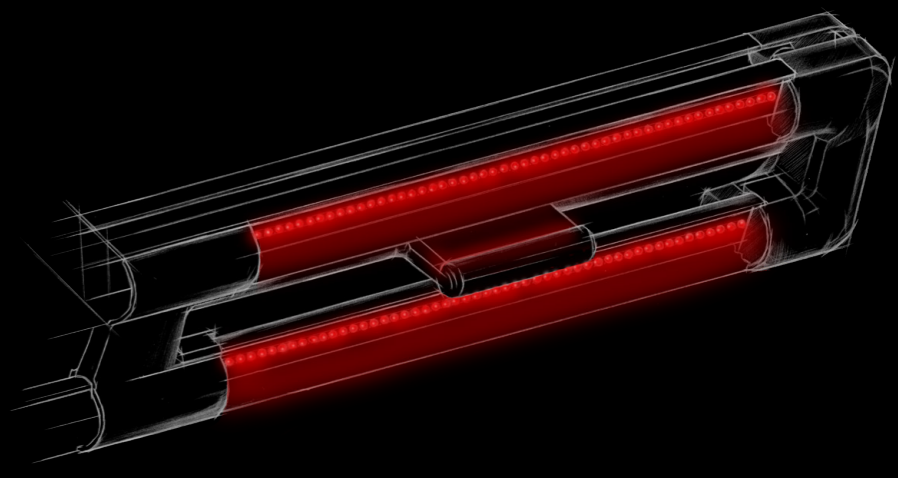

BEAUTIFYING REDLIGHT.

The K-Series also sets unique standards in skin care: More than 2.000 red Nano Beauty LEDs evenly distributed over the body provide gentle care for the face, décolleté and body. With their special wavelength range, they stimulate oxygen supply and natural collagen build-up of the skin. The effect of the Beauty LEDs ensures a healthy complexion and noticeably softer skin.



BeautyBooster Pro 

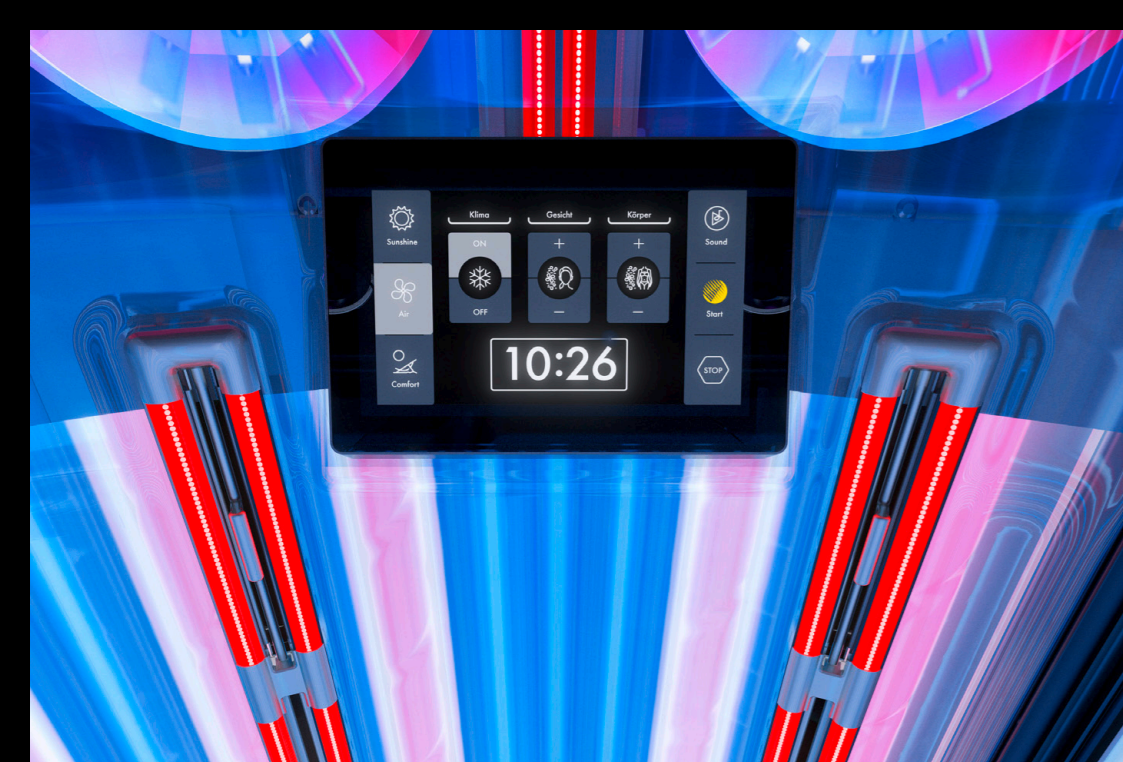

INTUITIVE TOUCH CONTROL

On the outside, the desired settings can be selected on a 10" display before the tanning session. Tanning studio operators also have access to a completely redesigned service menu via the external Touch displays. A new user interface makes tanning even easier. In the interior, all relevant parameters can be set easily and quickly on a 7" display during the tanning session.

7" SmartControl 



AMAZING SOUND

The new K-Series 3D Soundbar provides crystal-clear highs, powerful mids and rich bass in the tanning tunnel. Optimally controlled by a digital sound processor. Solarium users can choose between music or, for the first time, relaxation sounds. They can also listen to their own playlists via Bluetooth.

3D Soundbar 

Comfort at your fingertips.

10" SmartControl 



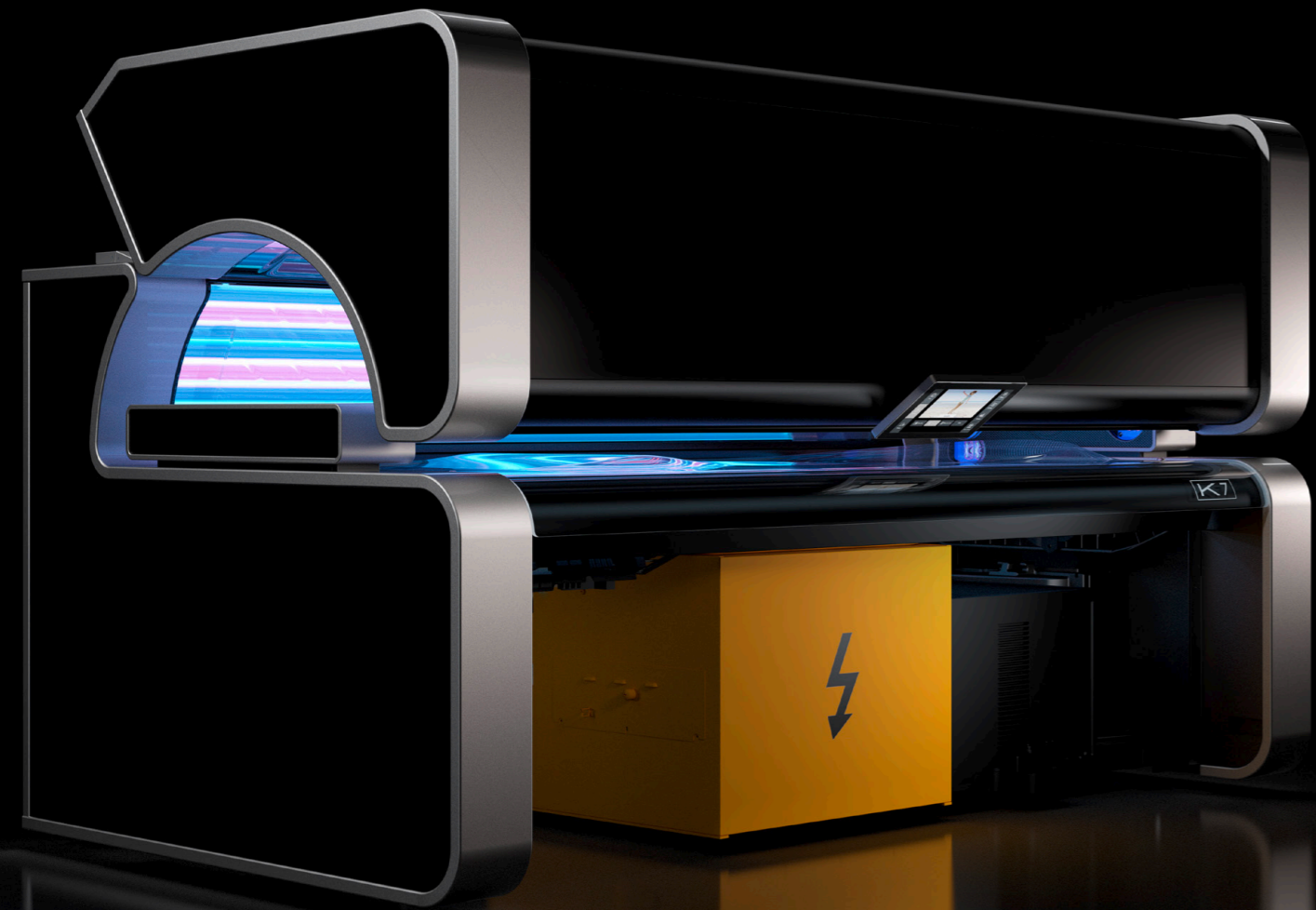

NEW ELECTRONICS

The heart of the K-Series is the completely new electronics. It has been entirely redeveloped and sets a totally new standard for future-oriented technology. This includes the innovative user interface which can be used to operate the solarium, simple in a comfortable way.

| KBL 8



FULLY CONNECTED

The solarium of tomorrow convinces with its diverse networking possibilities. With the K-Series, studio owners can centrally monitor the status of all units that are equipped accordingly. Diagnoses and software updates can be retrieved in the future via WLAN and network connection.

| WLAN & Connectivity

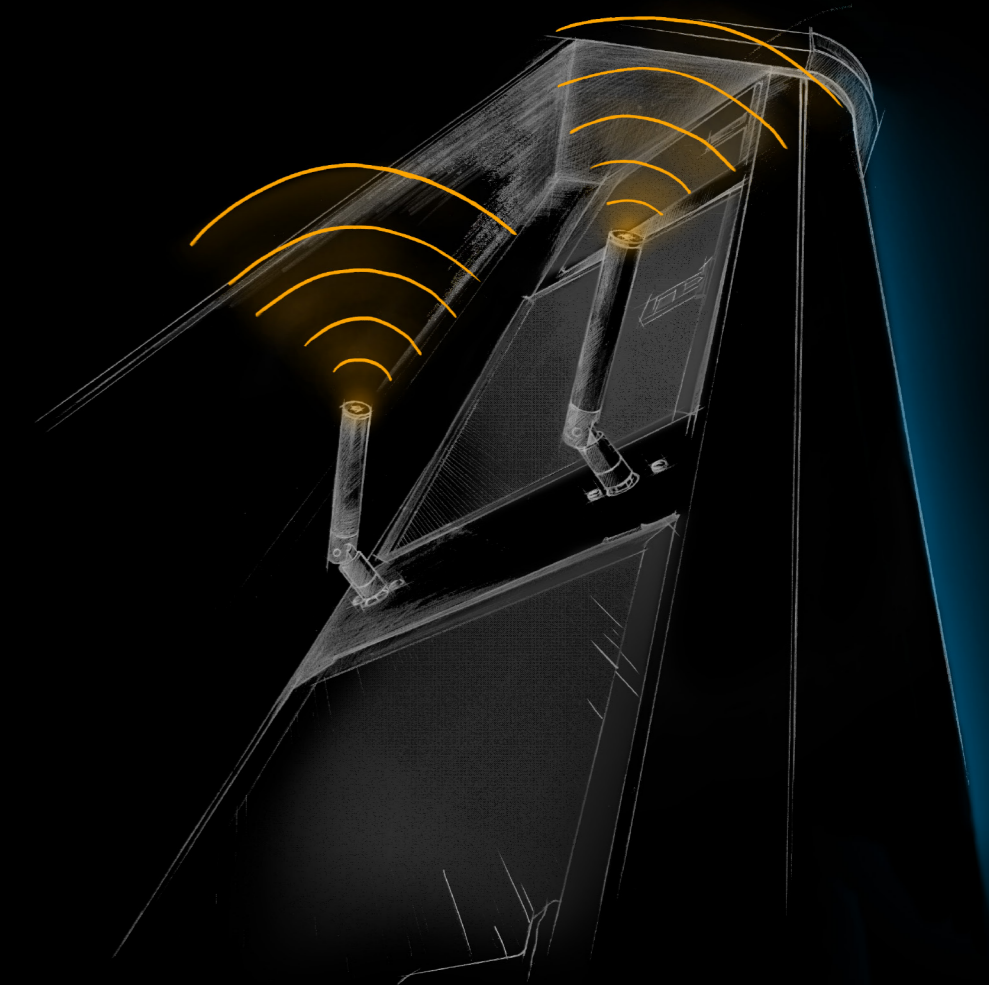



RELAX & ENJOY

For the first time, unique relaxation is provided not only by AirCondition but also by the individually adjustable dosage of the invigorating AquaCool mist. Scented air creates a unique fragrance experience, inspiring pleasure for all the senses. Users can completely relax during their tanning session and unwind from the daily grind.

| AquaCool & Aroma



| AirCondition



ENERGIZE YOUR PHONE

The inductive energy transfer is an ideal complement to its Bluetooth function. Wireless Charging for all suitable smartphones. Simply place the mobile phone in the mould in the surface and it will be charged. This allows your customers to recharge their body, mind and mobile phone at the same time.

| Wireless Charging



Uplifting Mechanics.

| LiftPro

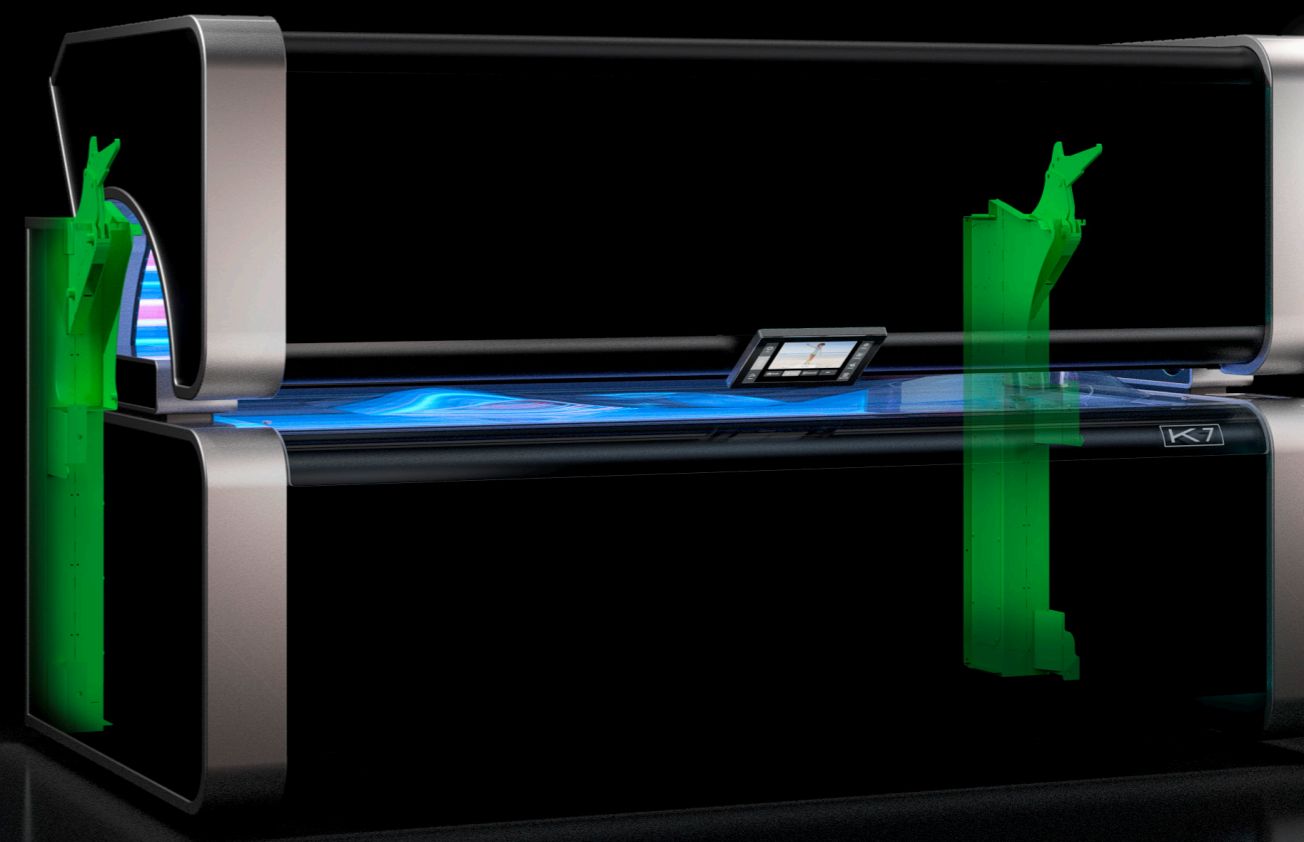
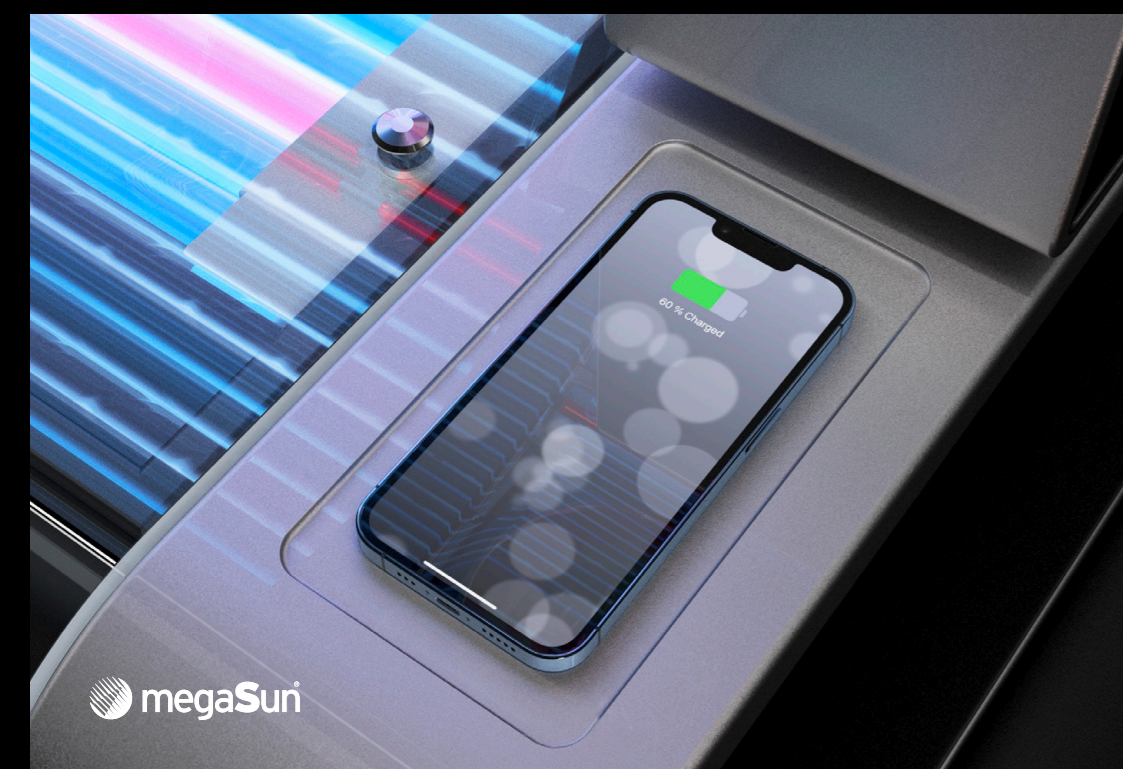

LIGHTSELECT - CHOOSE THE ONE

K7

hybridSun

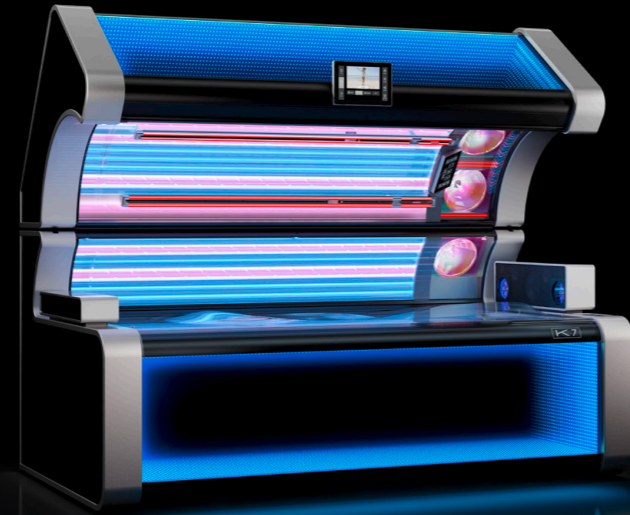

K7

extraSun

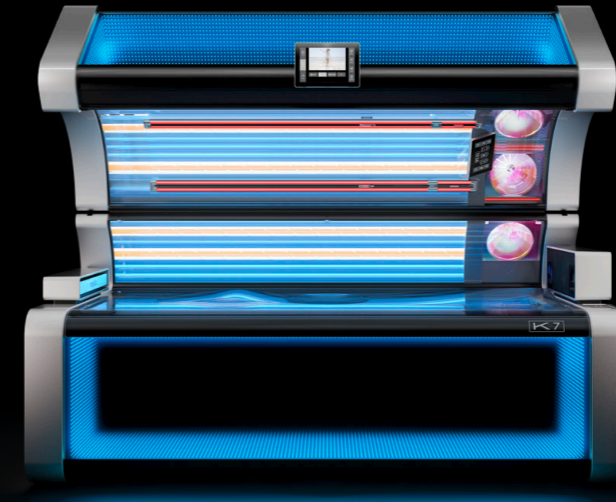

K7

smartSun



pureSunlight



Intensive sunlight for optimal tanning results.

extraSunlight



Sunlight with high UVB content for pigment development and vitamin D production.

smartSunlight



Sunlight combined with skin-caring beauty light.

pureFacials



Intensive sunlight for face and décolleté.

SunSphere Facials



Balanced spectrum of UVA and Beauty LEDs in combination.

SunSphere Shoulders



Balanced spectrum of UVA and Beauty LEDs.

1 2 3 4 5 6 7 8 9 10

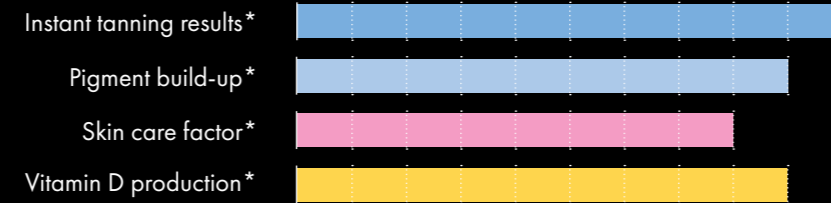

*Exemplary comparative depiction

1 2 3 4 5 6 7 8 9 10

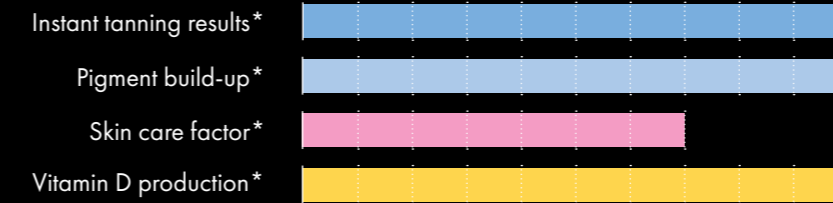

*Exemplary comparative depiction

1 2 3 4 5 6 7 8 9 10

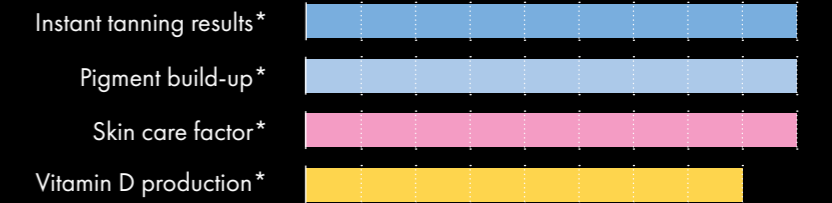

*Exemplary comparative depiction







LIGHTSELECT - CHOOSE THE ONE





























K6





























K7

K6 S

K7 S

- pureSunlight**  Intensive sunlight for optimal tanning results.
- extraSunlight**  Sunlight with high UVB content for pigment development and vitamin D production.
- smartSunlight**  Sunlight combined with skin-caring beauty light.
- pureFacials**  Intensive sunlight for face and décolleté.
- SunSphere Facials**  Balanced spectrum of UVA and Beauty LEDs in combination.
- SunSphere Shoulders**  Balanced spectrum of UVA and Beauty LEDs.

hybridSun	28  14  4  2 	32  14  4  2 
	> 2000 BeautyBooster Pro LEDs 	> 2000 BeautyBooster Pro LEDs 
extraSun	36  6  4  2 	40  6  4  2 
	> 2000 BeautyBooster Pro LEDs 	> 2000 BeautyBooster Pro LEDs 
smartSun	42  4  2 	46  4  2 
	> 2000 BeautyBooster Pro LEDs 	> 2000 BeautyBooster Pro LEDs 

hybridSun	28  14  4  2 	32  14  4  2 
	> 2000 BeautyBooster Pro LEDs 	> 2000 BeautyBooster Pro LEDs 
extraSun	36  6  4  2 	40  6  4  2 
	> 2000 BeautyBooster Pro LEDs 	> 2000 BeautyBooster Pro LEDs 
smartSun	42  4  2 	46  4  2 
	> 2000 BeautyBooster Pro LEDs 	> 2000 BeautyBooster Pro LEDs 

INDIVIDUAL CONFIGURATION



optional feature ○

Additional equipment options become a highlight in every studio.

defined standard ●

Convincing standard equipment for pleasant tanning.

DEVICE-SPECIFIC DATA

	K 6	K 7	K 6 S	K 7 S
AirBreeze Face	●	●	●	●
AirBreeze Body	●	●	●	●
BeautyBooster Pro	●	●	●	●
SmartControl 7"	●	●	●	●
Wireless Charging	●	●	●	●
3D Soundbar	○	○	●	●
AirCondition	○	○	●	●
AquaCool	○	○	●	●
Aroma	○	○	●	●
Bluetooth	○	○	●	●
Connectivity	○	○	●	●
SmartControl 10"	○	○	●	●
SunSphere Shoulders	○	○	●	●
Videofunktion	○	○	●	●
Voice Assist	○	○	●	●

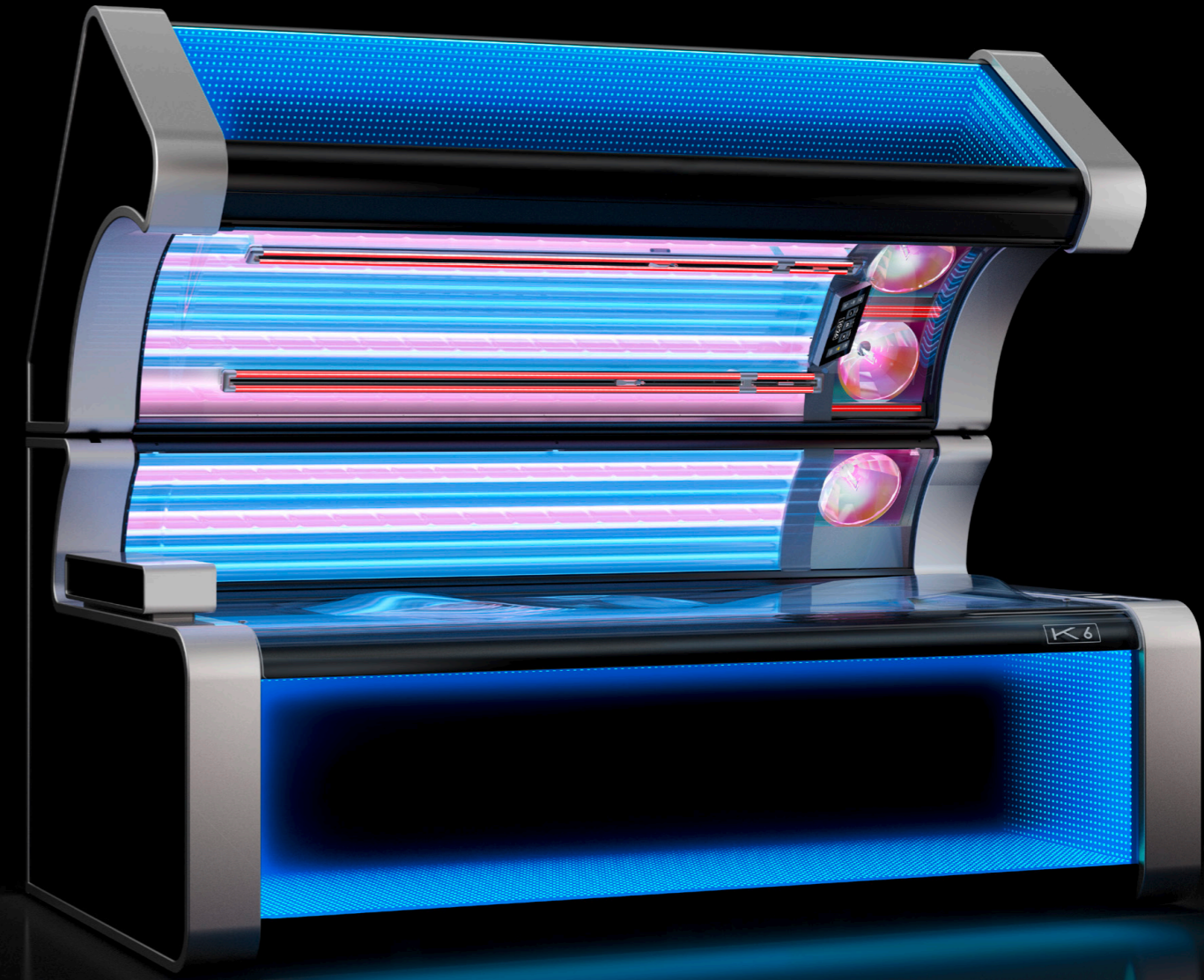

TECHNICAL DATA

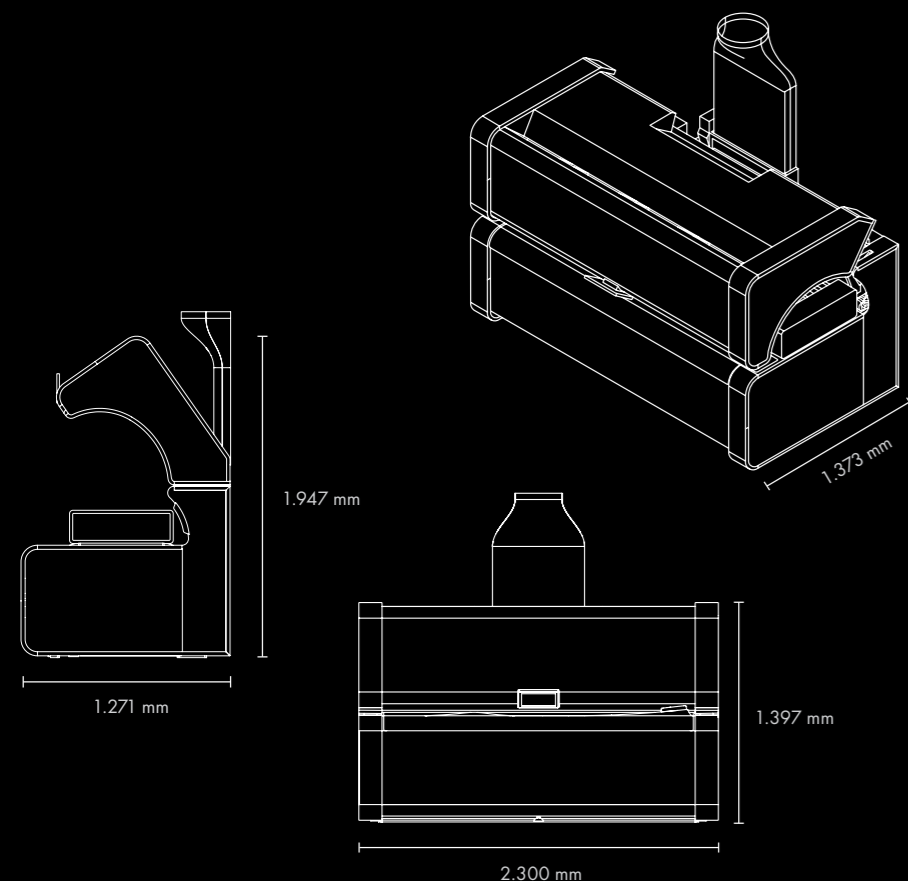

Dimensions (mm) Length x Width x Height

Closed:	2.300 mm x 1.373 mm x 1.397 mm
Open:	2.300 mm x 1.271 mm x 1.947 mm
	h with exhaust 2.096 mm

DEVICE-SPECIFIC DATA

	K6	K7	K6 S	K7 S
Maximum power consumption	12,6 kW	13,3 kW	10,5 kW	11,2 kW
Maximum power consumption (without aircon)	11,4 kW	12,1 kW	9,3 kW	10,0 kW

GENERAL DATA

Weight	ca. 705 kg (incl. aircon)
Bed pane max. load capacity	max. 150 kg

Electrical data Connection

Main voltage	400 V / ~3N / 50 Hz
Breaker	K-Automat 3-polig / 3 x 25 A mit FI (RCD)

Ambient conditions – In dry rooms (booths) with sufficient airing and ventilation

Recommended room size:	2.500 mm (Width) x 2.200 mm (Depth)
Maximum relative air humidity:	70%
Maximum room temperature:	30°C
Minimal distance to side walls:	100 mm
Minimum room height:	2.400 mm
Distance to backwall:	0 mm

“DESIGN IS COMMUNICATION.”

This is no pure styling, the process started from the technology, from the inside of the product, and evolved into a new DNA and creation of a new family of products, all recognizable and unique but all fitting each other's. The new design is pure but mostly modular, created to make every machine unique`.

- Etienne Salomé -

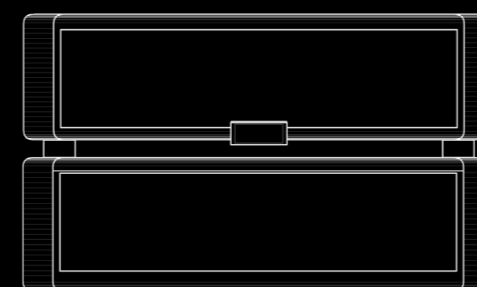

Etienne

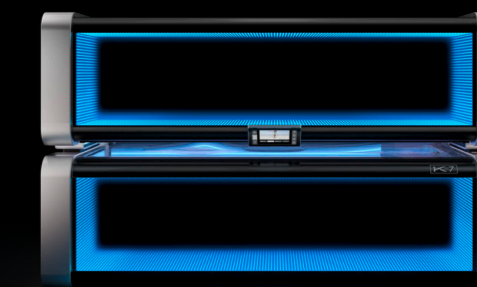
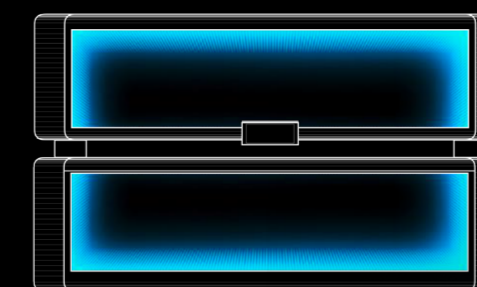

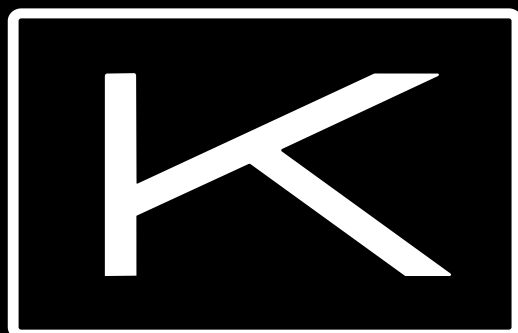

SERIES

KBL GmbH – The Beauty & Health Company · Ringstraße 24-26 · 56307 Dernbach
fon +49 (0) 26 89 - 94 26 - 0 · fax +49 (0) 26 89 - 94 26 - 66 · e-mail: info@kbl.de

www.megaSun.de



Copyright 2022 KBL GmbH, Germany

Errors and omissions possible. KBL reserves the right to change technical data or specifications without notice.

Art.-Nr. 3010170289