



Design by  
STUDIO F·A·PORSCHE



# IT ALL STARTS WITH A DREAM

Solarium design in the footsteps of the iconic Porsche 911.

Impressive technology and breathtaking design in perfect symbiosis. People all over the world are fascinated by the myth that is Porsche. Therefore, it was our dream to collaborate with Studio F. A. Porsche on an ambitious project of a new solarium design. To bring form and functionality together in perfect harmony. This dream has now come true:

With the P9 series, KBL presents a world first in close collaboration with Studio F. A. Porsche that sets new design standards for solariums. The P9 combines an elegant form with outstanding technical performance. Innovation that captivates customers. And at the same time, an homage to what energises and inspires us all: the sun.

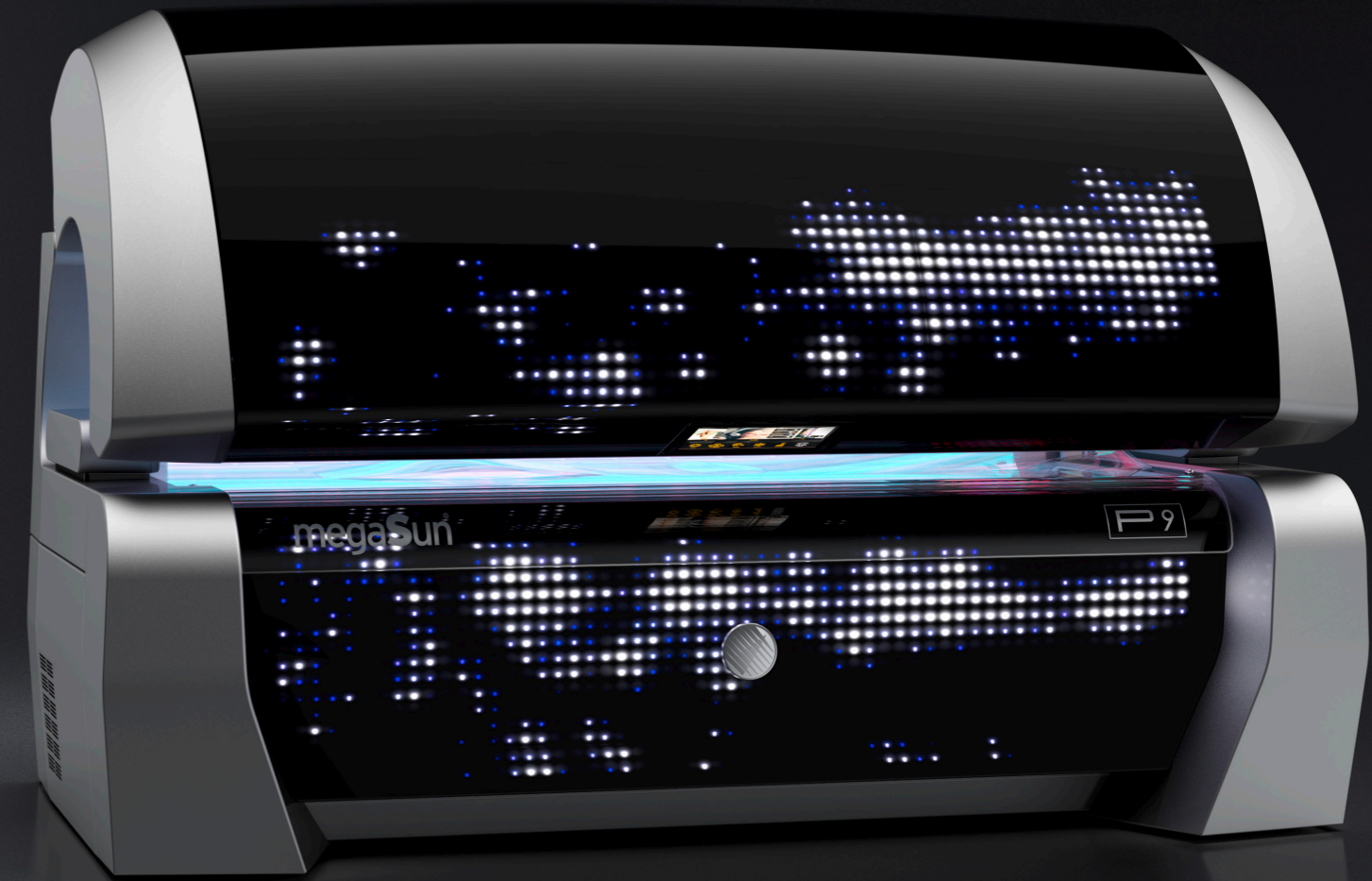





## DESIGN MEETS SUNSHINE

Designed to fascinate: With the Matrix Lightshow, the P9 sets new design standards. And convinces with features that leave nothing to be desired. For an unforgettable solarium experience.

### Features

-   
 Matrix Light
-   
 Wireless Charging
-   
 Intelligent Control System
-   
 Easy Control
-   
 Glass Facial System
-   
 Beauty Booster HyperRed
-   
 X-Tra Tan
-   
 Sound System
-   
 Mega Voice
-   
 Bluetooth
-   
 Aqua Cool
-   
 Aroma
-   
 Air Condition



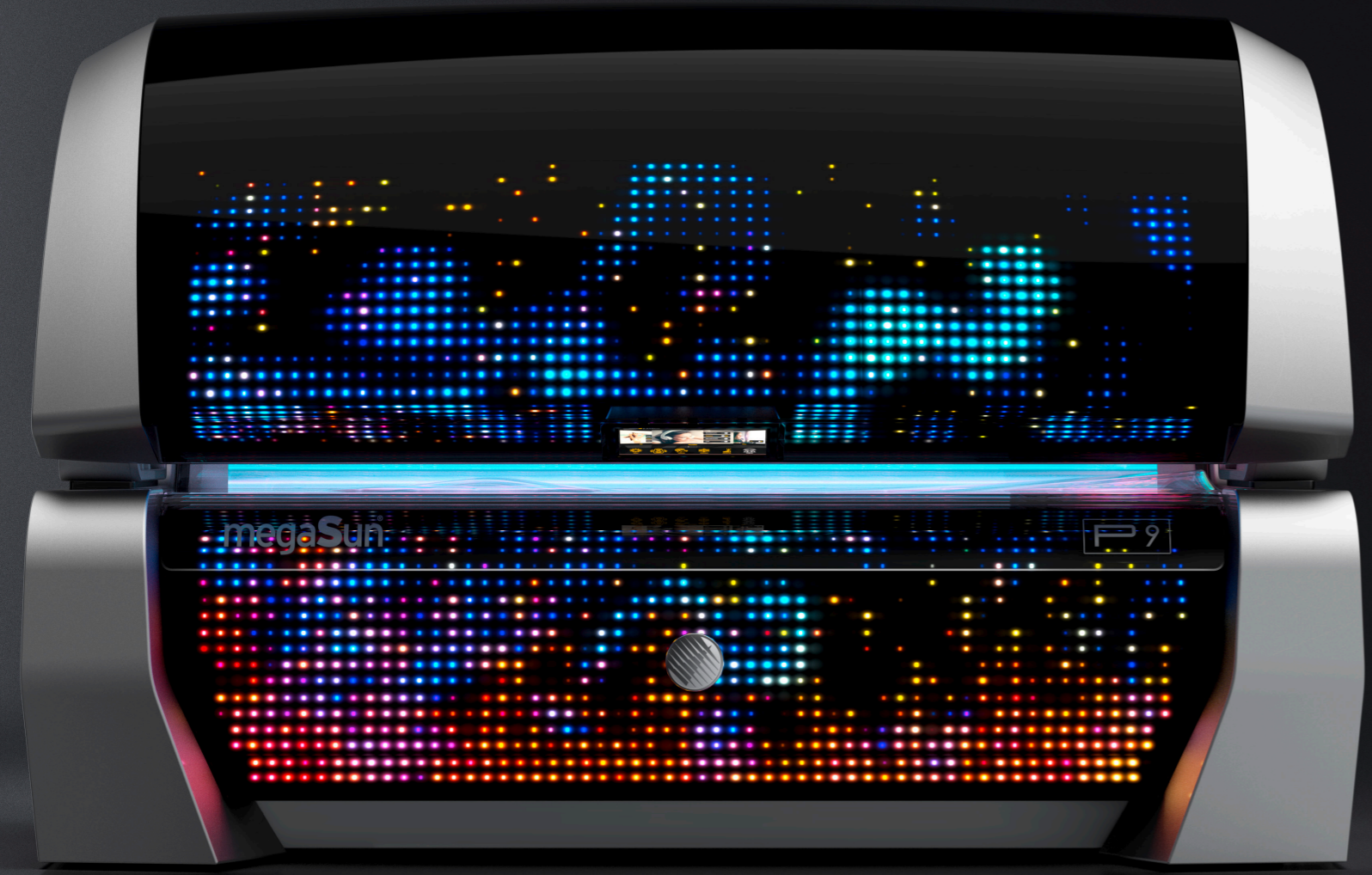

Design by  
STUDIO F·A·PORSCHE

# A STARGAZING LIGHTSHOW

## Eye-catcher and fascinating appearance.

From the first moment, the P9 captivates with its Matrix Lightshow. Over 2400 individually controllable special LEDs create extraordinary light animations in shape and color.

As a standard, the P9 comes equipped with a wide variety of lightshow programs.



Matrix Light

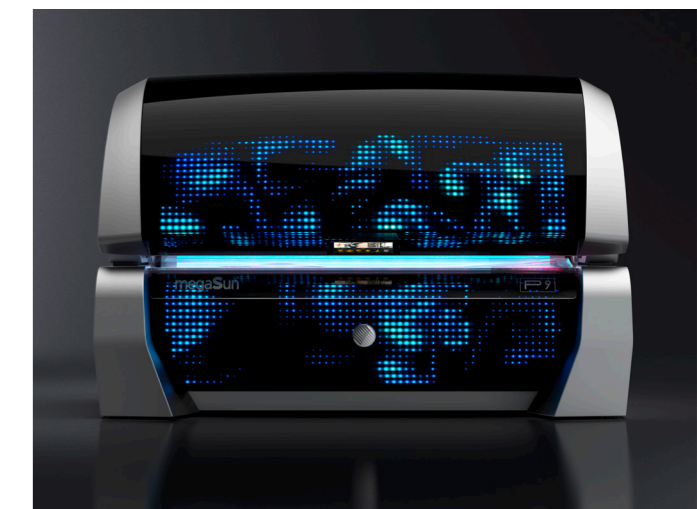
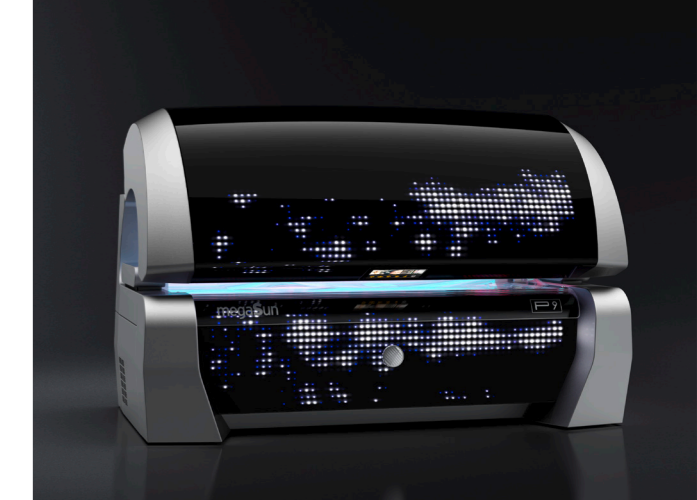



# HIGHLIGHT IN BLACK OR WHITE.

**The P9 by KBL: A design icon right from the start.**

The perfect choice for all salon concepts: With two body colors, the P9 is a true highlight in every environment. The P9's look and features turn every tanning session into an incredible experience that impresses customers again and again.



Design by  
STUDIO F·A·PORSCHE

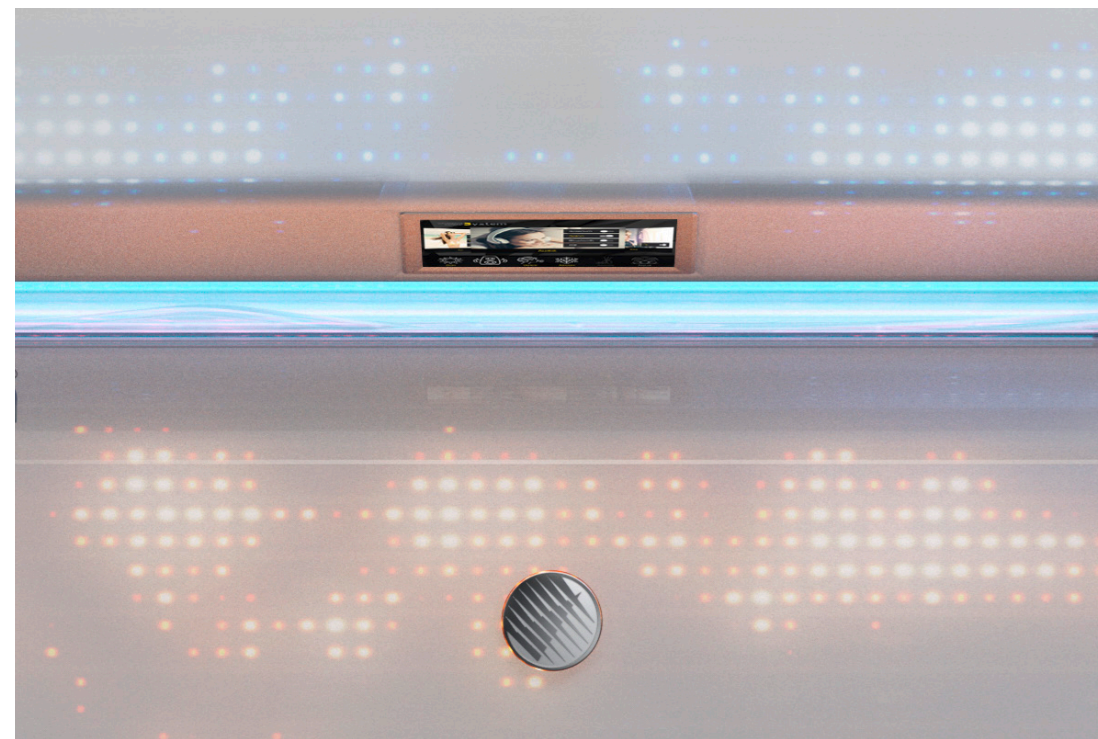



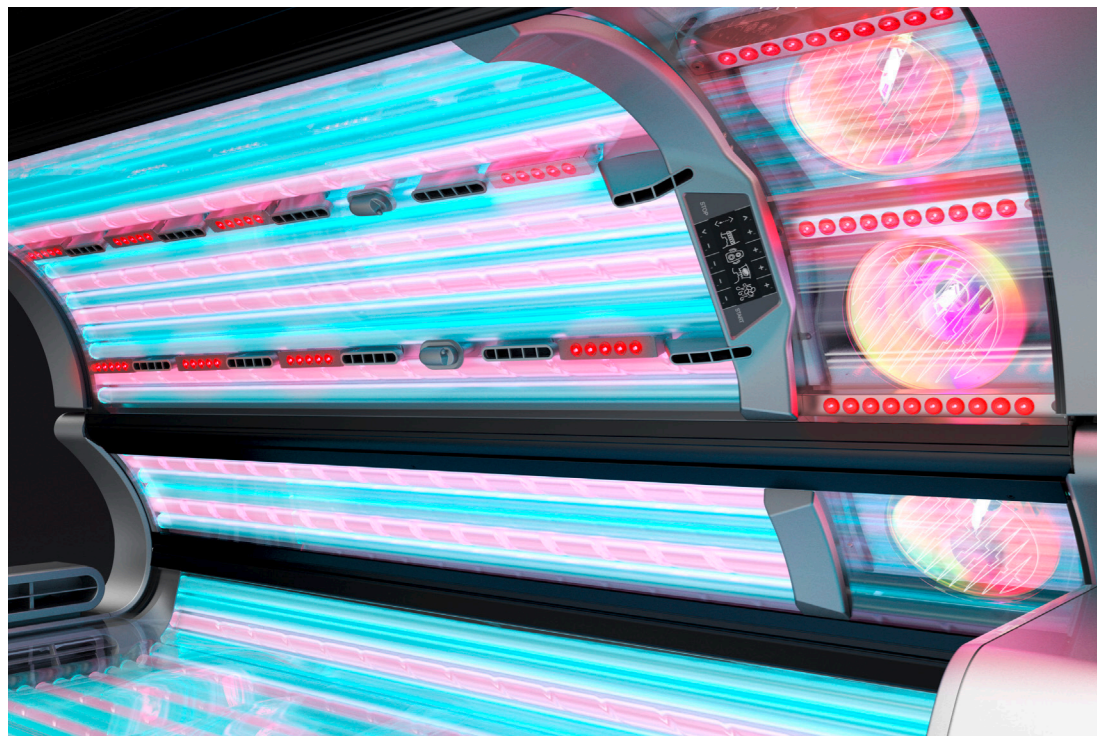

## PERFORMANCE LEADER.

Performance that leaves nothing to be desired: Intensive sunlight and skin-soothing beauty light for face and décolleté, specifically adjusted to work hand-in-hand and available in two variants. In addition, four spectral combinations in the body area. With Beauty-Boosters optimally spread out from head to toe.



Beauty  
Booster  
HyperRed



Glass  
Facial  
System



Light  
Select



## ATTENTION TO DETAIL.

A real design highlight: Shoulder tanner and sound system in perfect symbiosis. Extra sunlight, an excellent sound experience and voice-assisted guidance through the operating functions. First-class comfort that meets the highest standards.



X-Tra Tan



Sound  
System



Mega  
Voice







Design by  
STUDIO F-A-PORSCHÉ

## FOLLOW YOUR INTUITION.

Customers love the consistent operating logic in all KBL solariums. The P9 impresses with tried-and-tested function icons in a new look, clearly structured and intuitive to operate. Ease of use par excellence.



Easy  
Control



## SMART CONTROL.

A new look for the Intelligent Control System: Using the intuitive touch screen, individual customer requests and comfort features can be set before the tanning. Salon operators have easy access to all key maintenance and service settings.



Intelligent  
Control  
System







## BREATHE. RELAX. ENJOY.

---

Air condition for an optimal climate during tanning.  
Aqua Cool with revitalizing water mist for a pleasant refreshing experience. Aromatization of the air for a soothing scent.  
Enjoying the sun completely relaxed.



Air  
Condition



Aqua Cool



Aroma



## TOTALLY WIRELESS.

---

A world first in the P9 by KBL: Wireless charging for all suitable smartphones as a perfect addition to the Bluetooth function.  
Customers simply place the device on the corresponding icon and the smartphone immediately starts charging during the tanning session. Without any annoying cables.



Wireless  
Charging



Bluetooth





# THE POWER OF CHOICE.

## P9 hybridSun



**pureSunlight**  
Intensive sunlight for ideal tanning results.



**beautyLight**  
Soothing beauty light for an especially beautiful skin.



**smartSunlight**  
Intensive sunlight combined with soothing beauty light.



**extraSunlight**  
Sunlight with a high percentage of UVB for increased pigment development and vitamin D production.

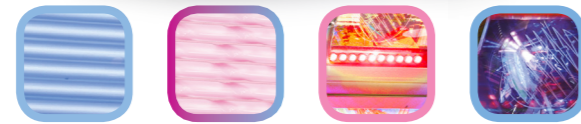

pure Sunlight smart Sunlight beauty Booster pure Facials

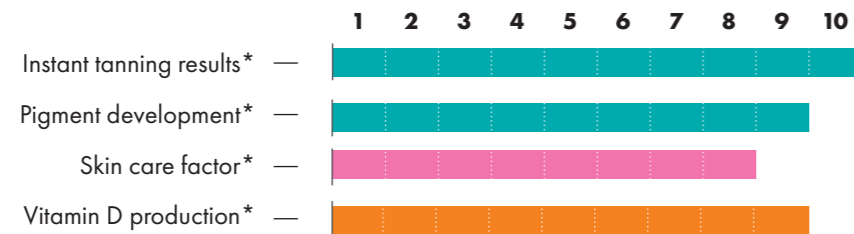

\*Exemplary comparative depiction

## P9 extraSun

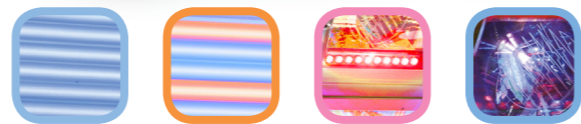

pure Sunlight extra Sunlight beauty Booster pure Facials

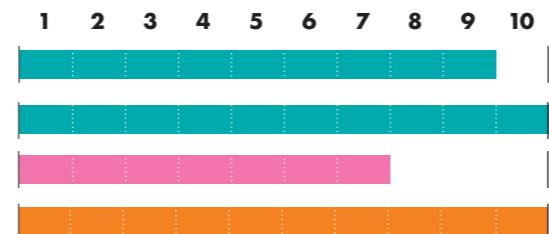

## P9 smartSun

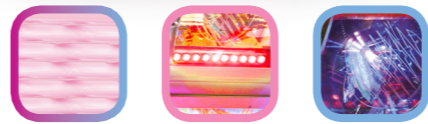

smart Sunlight beauty Booster pure Facials

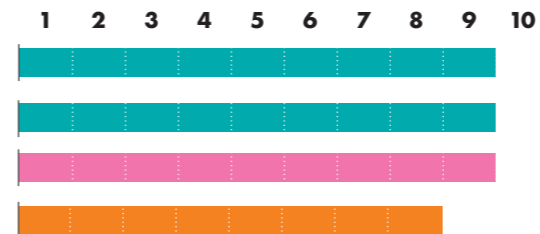

## P9 beautySun



pure Sunlight beauty Light beauty Booster smart Facials

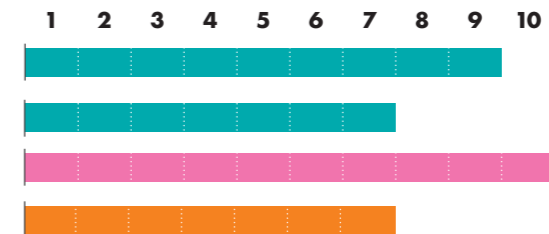

**pureFacials**  
Intensive sunlight for the face and décolleté.



**smartFacials**  
Intensive sunlight plus soothing beauty light for the face and décolleté area.



**beautyBooster HyperRed**  
Extra intensive beauty light for a beautiful skin.



— Instant tanning results\*  
— Pigment development\*  
— Skin care factor\*  
— Vitamin D production\*





**P9**

**Light Select options**

**hybridSun**

18 x 200 W (max.) pureSunlight lamps  
 8 x 200 W (max.) smartSunlight lamps  
 4 x 700 W pureFacials  
 70 x Beauty Booster HyperRed

16 x 200 W (max.) pureSunlight lamps  
 8 x 200 W (max.) smartSunlight lamps

**extraSun**

20 x 200 W (max.) pureSunlight lamps  
 6 x 200 W (max.) extraSunlight lamps  
 4 x 700 W pureFacials  
 70 x Beauty Booster HyperRed

24 x 200 W (max.) pureSunlight lamps

**smartSun**

26 x 200 W (max.) smartSunlight lamps  
 4 x 700 W pureFacials  
 70 x Beauty Booster HyperRed

24 x 200 W (max.) smartSunlight lamps

**beautySun**

18 x 200 W (max.) pureSunlight lamps  
 8 x 200 W (max.) beautyLight lamps  
 4 x 500 W smartFacials  
 70 x Beauty Booster HyperRed

16 x 200 W (max.) pureSunlight lamps  
 8 x 200 W (max.) beautyLight lamps



# TECHNICAL DATA

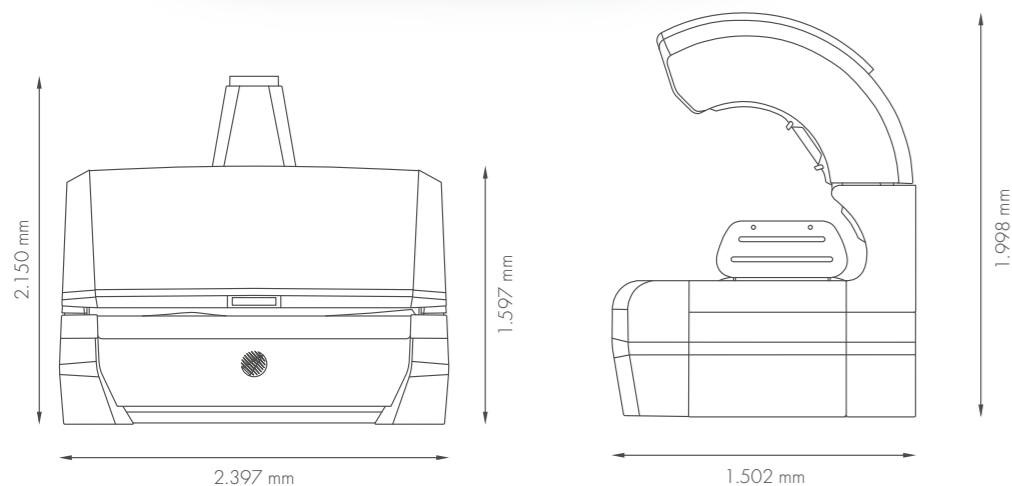

<b>Maximum power consumption</b>	14,5 kW
<b>Weight</b>	ca. 670 kg (with air condition)
<b>Bed pane max. load capacity</b>	max. 150 kg

## Electrical connection values

<b>Main voltage</b>	400 V / ~3N / 50 Hz
<b>Breaker</b>	Automatic fuse K-type (safety cut-out), 3-pole, 3 x 25A with residual current operated circuit breaker (RCD)

## Ambient conditions

In dry rooms (booths) with sufficient airing and ventilation  
 Recommended room size: 2.600 mm (Width) x 2.300 mm (Depth)  
 Maximum relative air humidity: 70%  
 Maximum room temperature: 30°C  
 Minimal distance to side walls: 100 mm  
 Minimum room height: 2400 mm  
 Distance to backwall: 0 mm

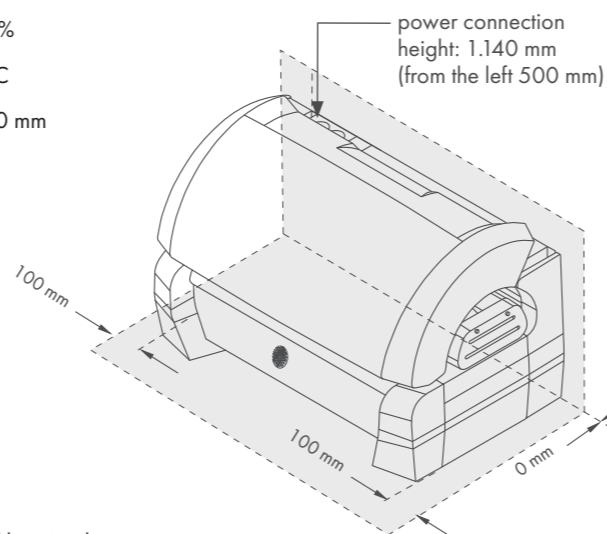

## Dimensions (mm) Length x Width x Height

Closed:	2.397 mm x 1.502 mm x 1.597 mm (2.150 mm h with exhaust)
Open:	2.397 mm x 1.502 mm x 1.998 mm (2.150 mm h with exhaust)

# FEATURE-HIGHLIGHTS

## Icons and their meaning



**Matrix Lightshow:** Over 2.400 special LEDs for extraordinary light animations in shape and color.



**Wireless Charging:** Simple, cableless charging of all suitable smartphones during tanning sessions.



**Intelligent Control System:** Intuitive function control for customers before the tanning session. Easy access to maintenance and service settings for operators.



**Easy Control:** Easy-to-use operation of all key functions during the tanning session. Clearly structured and intuitive.



**Glass Facial System:** Facial tanner with specially coated filter discs and glass reflectors. Maximum tanning comfort for face and décolleté.



**Beauty Booster HyperRed:** Extra-intensive beauty light for beautiful skin and a soothing feeling.



**Light Select:** Four specially coordinated spectral combinations in the body area: hybridSun, extraSun, smartSun and beautySun.



**X-tra Tan:** Even and intensive tanning in the shoulder area through modern high-pressure systems.



**Air Condition:** The high-performance air conditioner guarantees a pleasant cooling sensation during the tanning session.



**Aqua Cool:** Refreshing and revitalizing water mist from two special, drip-free jets.



**Aroma:** The air can be aromatized during tanning on request.

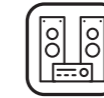

**Sound System:** Can be individually fitted and integrated into the solarium. The sound system for an excellent sound experience.



**Bluetooth:** Simply connect the smartphone with the solarium via Bluetooth. And listen to a personal playlist while tanning.



**Mega Voice:** A pleasant voice guides quickly and easily through the solarium's operating functions. Wellbeing is guaranteed right until it's time to say goodbye.





# Design must be honest!

These four words spoken by Prof. Ferdinand Alexander Porsche get to the heart of his philosophy in which design is not simply decoration or superficial beautification, but rather the perfect symbiosis of form and function. This can only be achieved once the functionality of a product is fully captured.



When the studio was founded in 1972 in Zell am See, F. A. Porsche had already delivered the evidence of this philosophy: the design for the Porsche 911. An unembellished, timeless design that embodies the technical essence of the sports car like a perfectly tailored suit.

A passionate expression of motion – even when still. The fascination for puristic design still motivates Studio F. A. Porsche today. It permeates all the areas for which Studio F. A. Porsche designs objects in the 21st century: product, transport and space design.

**STUDIO F·A·PORSCHE**





KBL GmbH – The Beauty & Health Company · Ringstraße 24-26 · 56307 Dernbach  
fon +49 (0) 26 89 - 94 26 - 0 · fax +49 (0) 26 89 - 94 26 - 66 · e-mail: info@kbl.de

[www.megaSun.de](http://www.megaSun.de)



Copyright 2019 KBL GmbH, Germany

Errors and omissions possible. KBL reserves the right to change technical data or specifications without notice.

Art.-Nr. 3010170275